

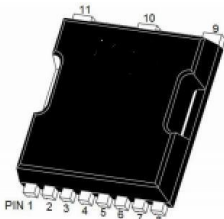

<p>General Description</p> <ul style="list-style-type: none"> ● Trench Power SGT technology ● Very low on-resistance $R_{DS(ON)}$ ● Low Gate Charge ● Excellent Gate Charge x $R_{DS(ON)}$ Product <p>Applications</p> <ul style="list-style-type: none"> ● High Frequency Switching and Synchronous Rectification 	<p>Product Summary</p> <table style="width: 100%; border: none;"> <tr> <td style="width: 60%;">V_{DS}</td> <td>40V</td> </tr> <tr> <td>I_D (at $V_{GS}=10V$)</td> <td>200A</td> </tr> <tr> <td>$R_{DS(ON)}$ (at $V_{GS}=10V$)</td> <td>= 0.98 mΩ</td> </tr> </table> <p>100% DVDS Tested 100% UIS Tested</p> <div style="text-align: right;">  </div>	V_{DS}	40V	I_D (at $V_{GS}=10V$)	200A	$R_{DS(ON)}$ (at $V_{GS}=10V$)	= 0.98 mΩ
V_{DS}	40V						
I_D (at $V_{GS}=10V$)	200A						
$R_{DS(ON)}$ (at $V_{GS}=10V$)	= 0.98 mΩ						

Toll

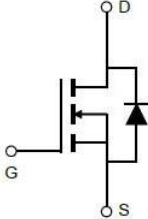



Part Number	Package Type	Form	Marking
PW4020L	TOLL	Reel	PW4020L

Absolute Maximum Ratings ($T_A = 25^\circ C$ unless otherwise noted)

Parameter	Symbol	Maximum	Units
Drain-Source Voltage	V_{DS}	40	V
Gate-Source Voltage	V_{GS}	± 20	V
Continuous Drain Current	I_D	$T_C = 25^\circ C$	200
		$T_C = 100^\circ C$	120
Pulsed Drain Current A	I_{DM}	520	A
Avalanche Current A	I_{AS}	50	A
Single Pulse Avalanche Energy $L = 0.5mH^B$	E_{AS}	720	mJ
Power Dissipation $T_C = 25^\circ C$ -Derating factor	P_D	240	W
		2	W/°C
Junction and Storage Temperature Range	T_J, T_{STG}	-55 to 150	°C

Thermal Characteristics

Parameter	Symbol	Maximum	Units
Maximum Junction-to-Case	$R_{\theta JC}$	1.0	°C/W
Steady-State			
Maximum Junction-to-Ambient	$R_{\theta JA}$	50	



Electrical Characteristics($T_J = 25^\circ\text{C}$ unless otherwise noted)						
Symbol	Parameter	Conditions	Value			Units
			Min	Typ	Max	
STATIC PARAMETERS						
BV_{DSS}	Drain-Source Breakdown Voltage	$I_D = 250\mu\text{A}, V_{GS} = 0\text{V}$	40			V
I_{DSS}	Zero Gate Voltage Drain Current	$V_{DS} = 40\text{V}, V_{GS} = 0\text{V}$	$T_J = 25^\circ\text{C}$		1	μA
			$T_J = 125^\circ\text{C}$		100	
I_{GSS}	Gate-Body Leakage Current	$V_{DS} = 0\text{V}, V_{GS} = \pm 20\text{V}$			± 100	nA
$V_{GS(th)}$	Gate Threshold Voltage	$V_{DS} = V_{GS}, I_D = 250\mu\text{A}$	1.0	1.7	2.5	V
$R_{DS(on)}$	Static Drain-Source On-Resistance	$V_{GS} = 10\text{V}, I_D = 20\text{A}$		0.98	1.2	$\text{m}\Omega$
g_{FS}	Forward Transconductance	$V_{DS} = 10\text{V}, I_D = 10\text{A}$		60		S
V_{SD}	Diode Forward Voltage	$I_S = 20\text{A}, V_{GS} = 0\text{V}$			1.2	V
I_S	Maximum Body-Diode Continuous Current				120	A
DYNAMIC PARAMETERS						
C_{iss}	Input Capacitance	$V_{GS} = 0\text{V}, V_{DS} = 20\text{V}, f = 1\text{MHz}$		5332		pF
C_{oss}	Output Capacitance			2120		
C_{rss}	Reverse Transfer Capacitance			92		
SWITCHING PARAMETERS						
$Q_g(10V)$	Total Gate Charge	$V_{GS} = 10\text{V}, V_{DS} = 20\text{V}, I_D = 65\text{A}$		84		nC
Q_{gs}	Gate Source Charge			30		
Q_{gd}	Gate Drain Charge			17		
$t_{D(on)}$	Turn-On Delay Time	$V_{GS} = 10\text{V}, V_{DS} = 15\text{V}, I_D = 90\text{A}, R_G = 1.6\Omega$		12		ns
t_r	Turn-On Rise Time			48		
$T_{D(off)}$	Turn-Off Delay Time			24		
t_f	Turn-Off Fall Time			9.2		
t_{rr}	Body Diode Reverse Recovery Time	$I_F = 60\text{A}, di/dt = 100\text{A}/\mu\text{s}$		24		ns
Q_{rr}	Body Diode Reverse Recovery Charge			44		nC

A. Single pulse width limited by maximum junction temperature.

B. $T_J = 25^\circ\text{C}, V_{DD} = 25\text{V}, V_G = 10\text{V}, L = 0.5\text{mH}, R_g = 25\Omega$

C. The power dissipation P_D is based on $T_{J(MAX)} = 150^\circ\text{C}$, using junction-to-case thermal resistance, and is more useful in setting the upper dissipation limit for cases where additional heatsinking is used.

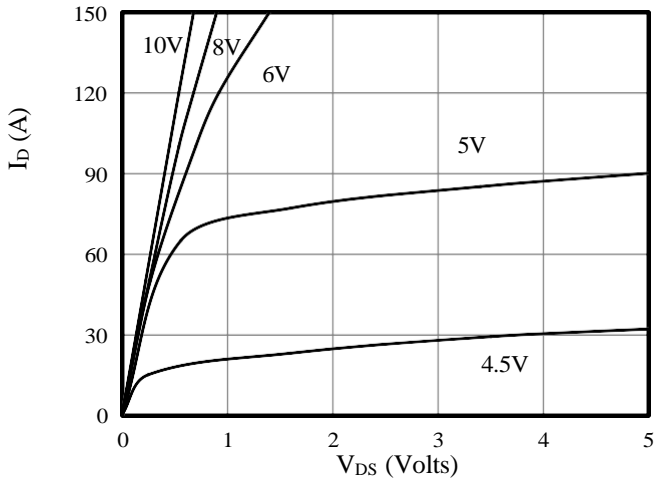

Figure 1: On-Region Characteristics

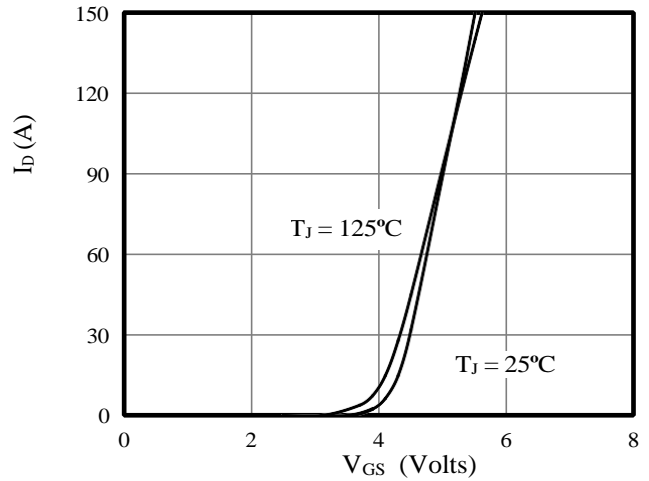

Figure 2: Transfer Characteristics

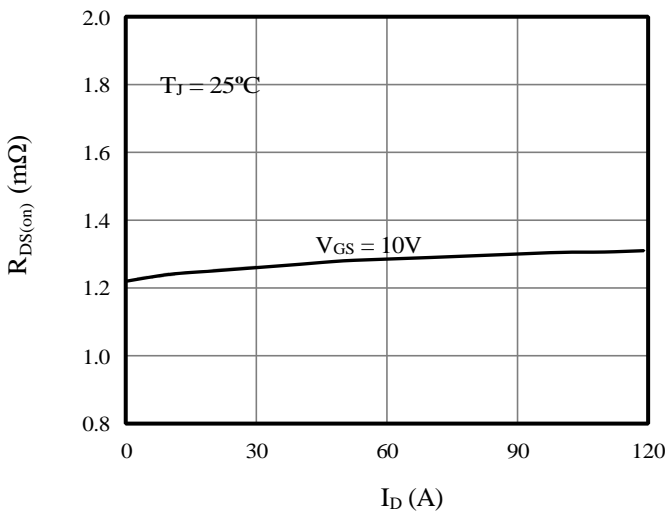

Figure 3: On-Resistance vs. Drain Current

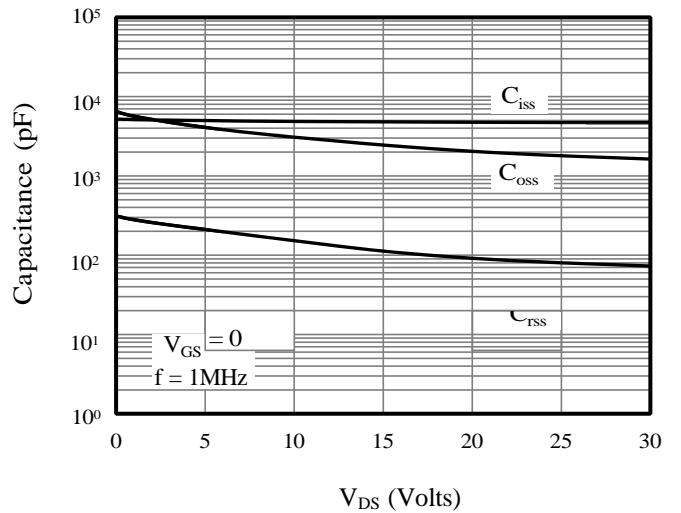

Figure 4: Capacitance Characteristics

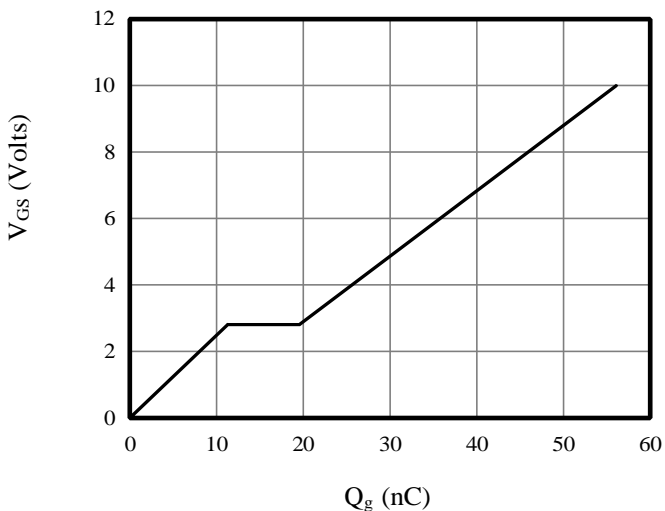

Figure 5: Gate Charge Characteristics

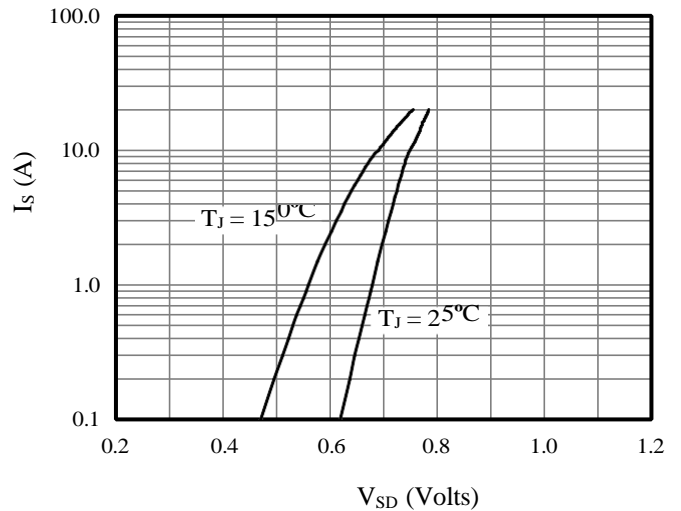

Figure 6: Body Diode Forward Voltage

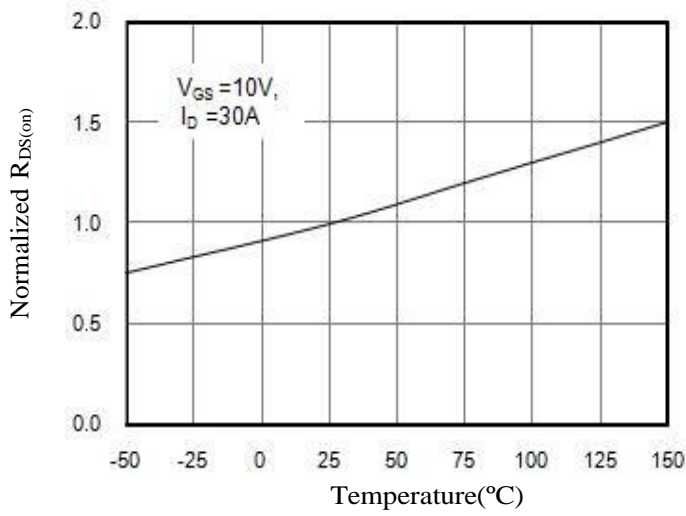

Figure 7: On-Resistance vs. Junction Temperature

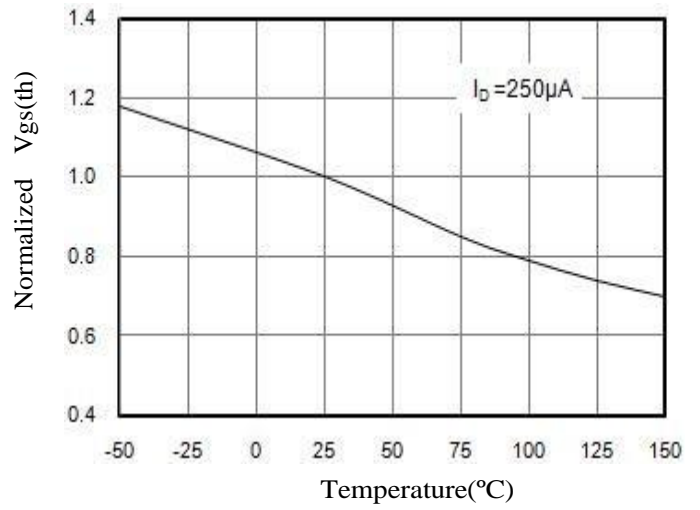

Figure 8: $V_{GS(th)}$ vs. Junction Temperature

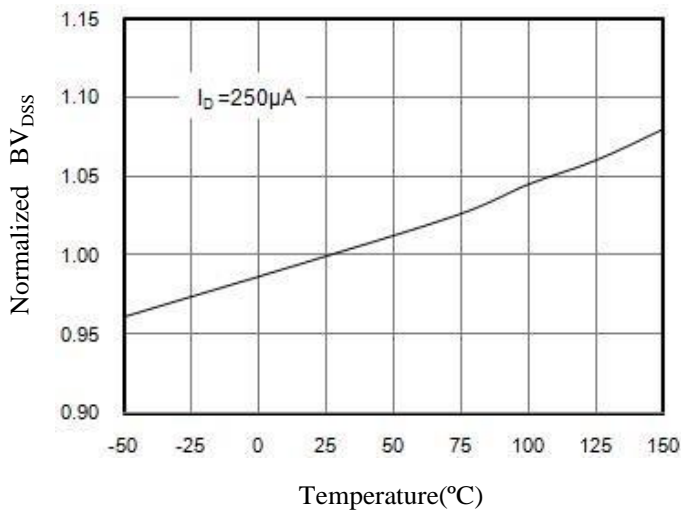

Figure 9: BV_{DS} vs. Junction Temperature

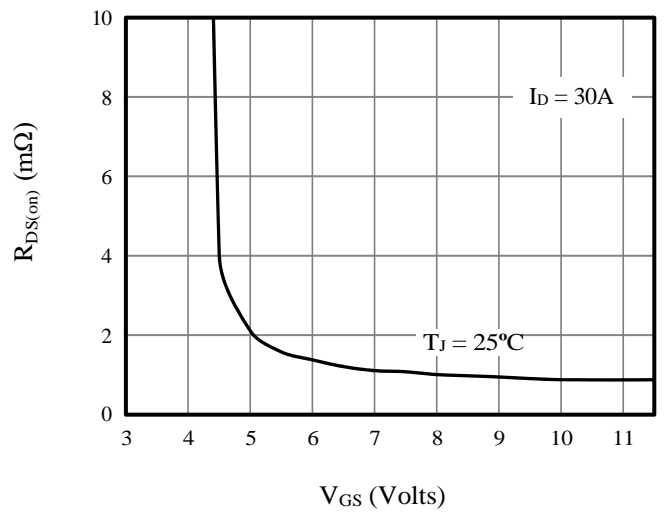

Figure 10: On-Resistance vs. Gate-Source Voltage



Figure A: Gate Charge Test Circuit and Waveforms

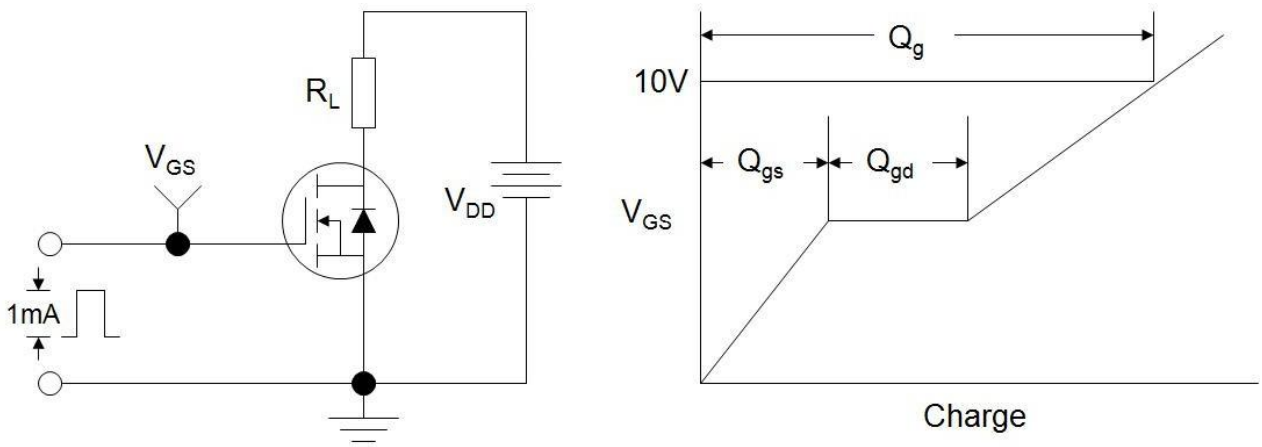

Figure B: Resistive Switching Test Circuit and Waveforms

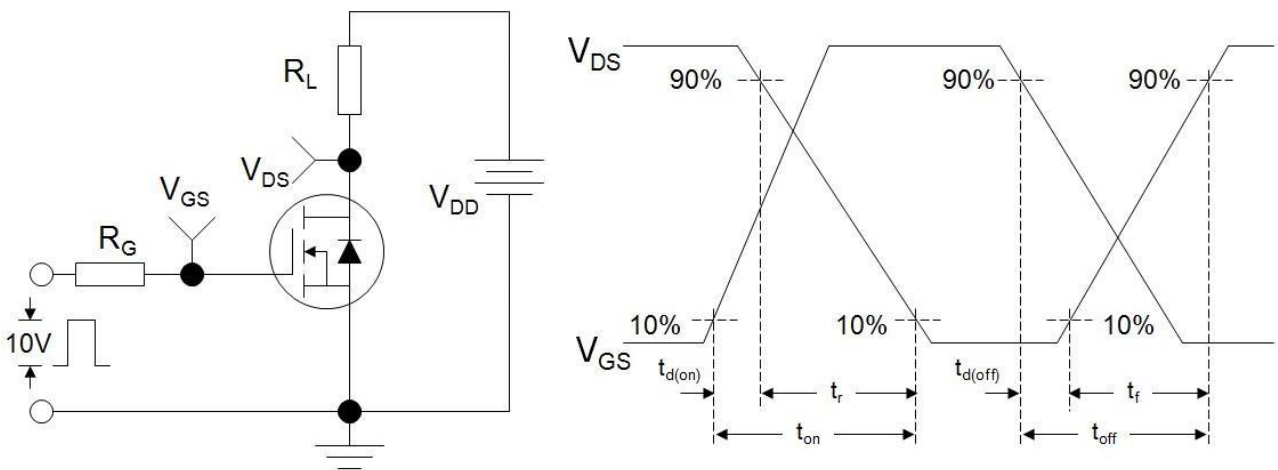
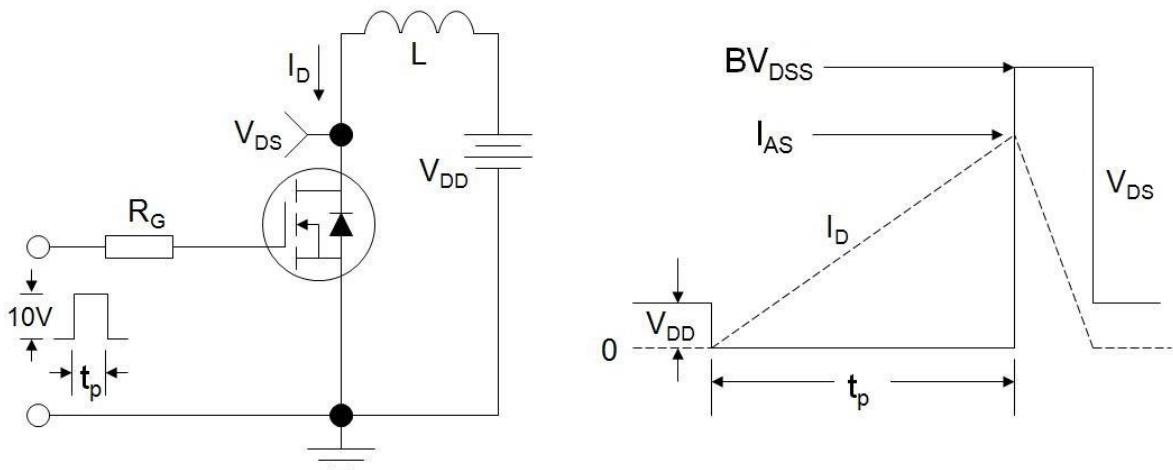
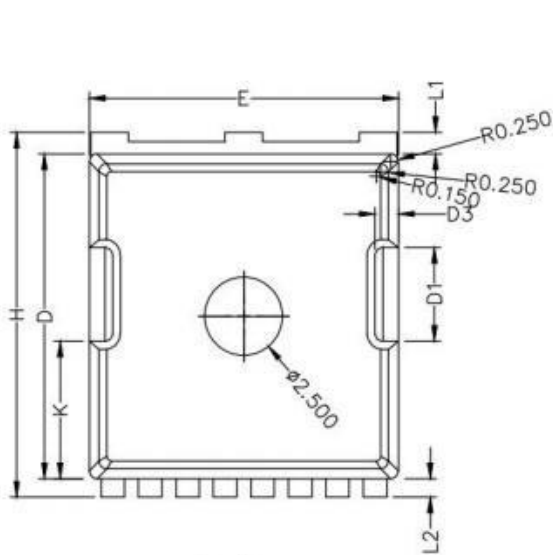

Figure C: Unclamped Inductive Switching (UIS) Test Circuit and Waveforms





TOLL



Top View

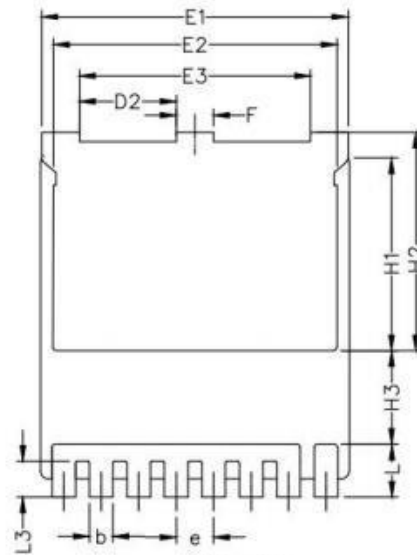

Bottom View

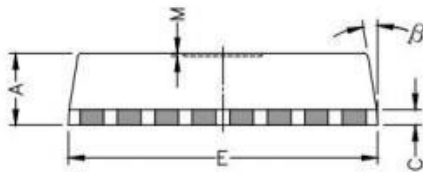

Symbols	Millimeters		
	MIN.	NOM.	MAX.
A	2.20	2.30	2.40
b	0.65	0.75	0.85
C	0.508 REF		
D	10.25	10.40	10.55
D1	2.85	3.00	3.15
D2	2.95	3.10	3.25
D3	0.75 REF		
E	9.75	9.90	10.05
E1	9.65	9.80	9.95
E2	8.95	9.10	9.25
E3	7.25	7.40	7.55
e	1.20 BSC		
F	1.05	1.20	1.35
H	11.55	11.70	11.85
H1	6.03	6.18	6.33
H2	6.85	7.00	7.15
H3	3.00 BSC		
L	1.55	1.70	1.85
L1	0.55	0.70	0.85
L2	0.45	0.60	0.75
L3	1.00	1.15	1.30
M	0.08 REF		
β	8°	10°	12°
K	4.25	4.40	4.55